

LOW VOLTAGE TRACKS

ST1

STANDARD LOW VOLTAGE 4 CONDUCTORS TRACK 9500/B-ST1 9500/W2-ST1

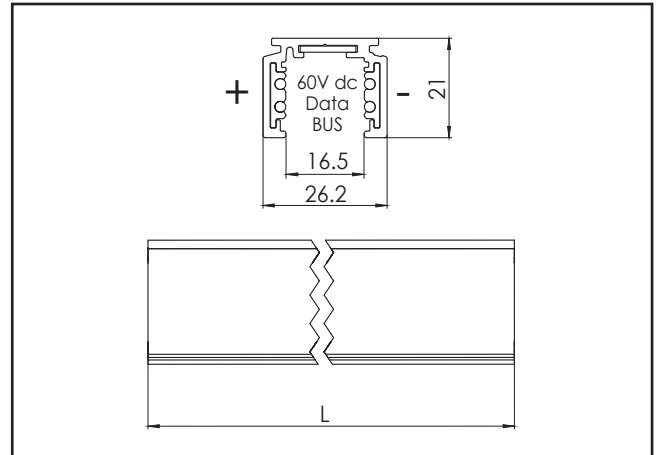

Technical data

• Rated current and voltage

15A / 60V dc

Characteristics

- 2 circuits: 2x +/- 15A/0-60V dc
- 1 circuit + Data Bus: +/- 15A/0-60V + D+/D-
- Length: 1000 mm, 2000mm, 3000 mm
- External extruded body in aluminium.
- Available colours: Embossed black RAL 9005(B) and embossed white RAL 9016 (W2)
- Insulated extruded body in PVC
- Copper conductors
- Quality marks : Class 2 (2A - 48Vdc / 4A - 24V dc )
- European directives : "RoHS" compliant
- Net weight 698.7g, 1397,3g, 2096g
- Track for both polarized and non polarized versions



Ceiling
mounting



Suspension
mounting



Class III

LOW VOLTAGE TRACKS

ST1

Track accessories

9504/ST1-B-F 9504/ST1-W2-F 9504/ST1-B 9504/ST1-W2 END CAPS



9504/ST1-W2-F
9504/ST1-B-F



9504/ST1-W2
9504/ST1-B

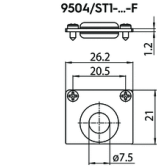
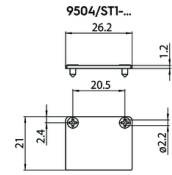

9504/ST1-P-B-F 9504/ST1-P-W2-F 9504/ST1-P-B 9504/ST1-P-W2 END CAPS

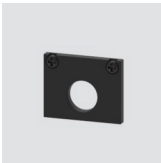

9504/ST1-P-W2-F
9504/ST1-P-B-F



9504/ST1-P-W2
9504/ST1-P-B

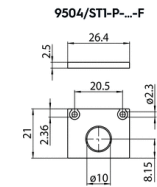
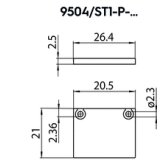

S-9000/T

CUTTING TOOL FOR TRACK CONDUCTORS

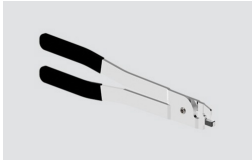

Connections



9501-S/B-E
9501-S/W-E
SHORT END-FEED



Snap - in
Fixing



Terminals with
screw and nut



Solid CU wire
or solder clipped
stranded or
bonded stranded
conductors



Wires
stripping



SELV
Class III

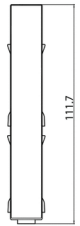

9503-S/B-E
9503-S/W-E
JOINTING CONNECTOR



Snap - in
Fixing



SELV
Class III

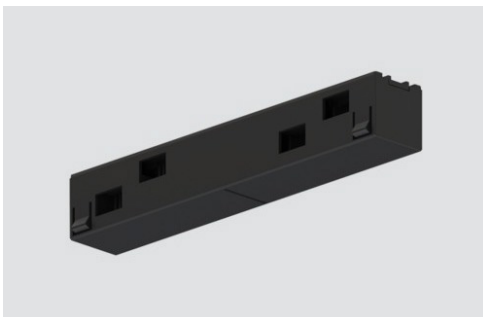
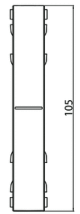

9503-S/B-M-E
9503-S/W-M-E
MECHANICAL JOINTING CONNECTOR



Snap - in
Fixing



SELV
Class III

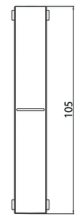

9511/B-E
9511/W-E
L FEED



Snap - in
Fixing



SELV
Class III

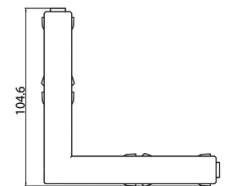

9518-S/B-E
9518-S/W-E
ADJUSTABLE CORNER



Snap - in
Fixing



SELV
Class III

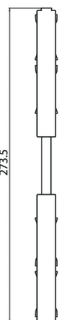

LOW VOLTAGE TRACKS

ST1

Connection joinings accessories



S-9511/316-LA
L BRACKET FOR ANGLES

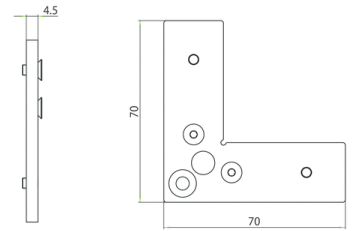

ST1 track - Suspension set



- S-RE-P-B
- S-RE-P-W2

SET FOR CEILING MOUNTING
WITH CUP AND TERMINAL BLOCK

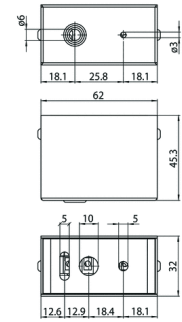

Cups



S-9000/3-B
S-9000/3-W
PLASTIC CUP FOR STEEL CABLE \varnothing 1,5 MM

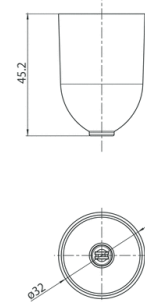

S-9000/216
ROUND HEAD CEILING ATTACHMENT
WITH HOLE

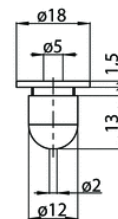

Ceiling fixing Brackets



S-9000/132
CEILING BRACKET FOR SUSPENSIONS

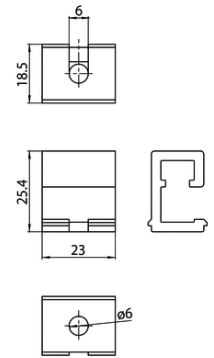

Stem



S-9000-1,2/604-B
S-9000-1,2/604-W2
STEM WITH M13x1 END AND NUT

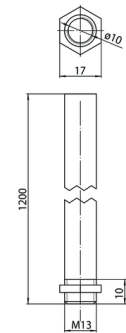

Cables



S-9000/211-1,5
S-9000/211-3
S-9000/211-5
STEEL CABLE

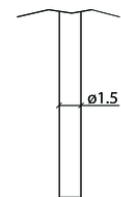

S-9000/211-S-1,5
S-9000/211-S-3
S-9000/211-S-5
STEEL CABLE WITH SPHERICAL END

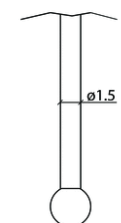

Grippers



S-9000/214
AUTOMATIC LOCK

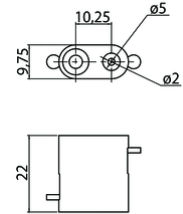

S-9000/215
SCREW GRIPPER

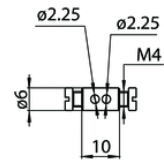

S-9000/218
AUTOMATIC M5 GRIPPER WITH SIDE HOLE

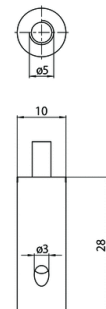

602/F
SET SCREW FOR GRIPPER ON THE BRACKET

