

LOW VOLTAGE TRACKS

ST5

TRIMLESS LOW VOLTAGE 4 CONDUCTORS TRACK
9500-1/B-ST5 9500-1/W2-ST5

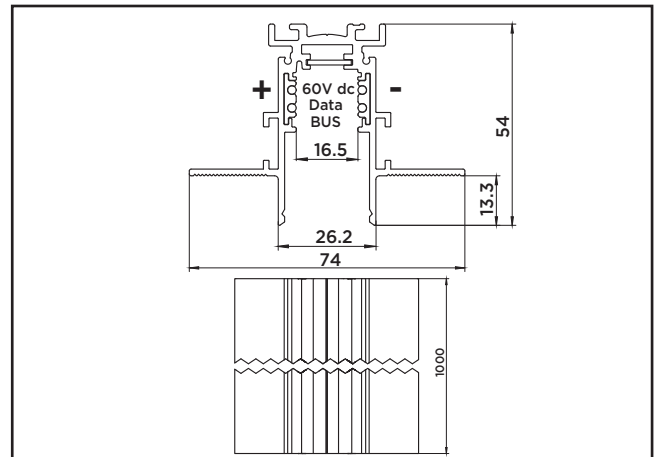
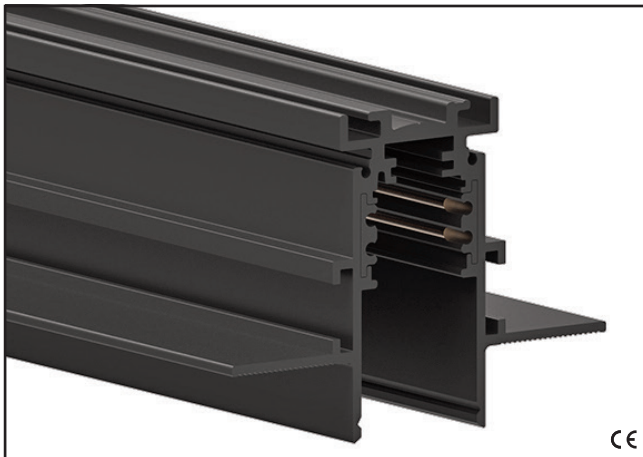

Technical data

• Rated current and voltage

15A / 60V dc

Characteristics

- 2 circuits: 2x +/- 15A/0-60V dc
- 1 circuit + Data Bus: +/- 15A/0-60V + D+/D-
- Length: 1000 mm, 2000mm, 3000 mm
- External extruded body in aluminium.
- Available colours: Embossed black RAL 9005(B) and embossed white RAL 9016 (W2)
- Insulated extruded body in PVC
- Copper conductors
- Quality marks : Class 2 (2A - 48Vdc / 4A - 24V dc )
- European directives : "RoHS" compliant
- Track for both polarized and non polarized versions



Trimless
fixing



Class III

LOW VOLTAGE TRACKS

ST5

Track accessories

9504/ST2-B-F 9504/ST2-W2-F 9504/ST2-B 9504/ST2-W2

END CAPS



9504/ST2-B-F
9504/ST2-W2-F



9504/ST2-B
9504/ST2-W2

9504/ST2-... 9504/ST2-...-F

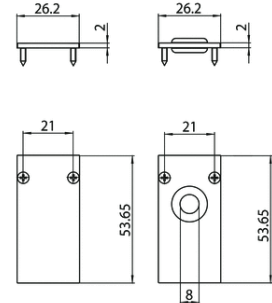

9504/ST2-P-B-F 9504/ST2-P-W2-F 9504/ST2-P-B 9504/ST2-P-W2

END CAPS

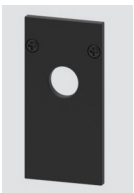

9504/ST2-P-B-F
9504/ST2-P-W2-F



9504/ST2-P-B
9504/ST2-P-W2

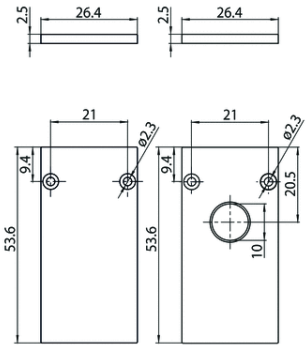

S-9500-L/B

PLASTER INSTALLATION GUARD

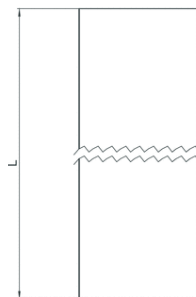
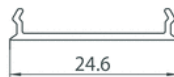

S-9500/LE-B-3000 S-9500/LE-W2-3000

OPAL SCREEN TL=56%

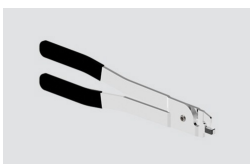
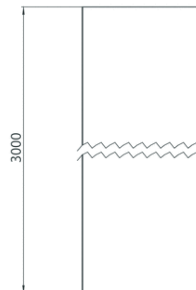

S-9000/T

CUTTING TOOL FOR TRACK CONDUCTORS

Connections



9501-S/B-E
9501-S/W-E
SHORT END-FEED



Snap - in
Fixing



Terminals with
screw and nut

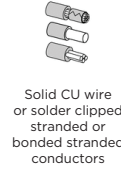

Solid CU wire
or solder clipped
stranded or
bonded stranded
conductors



Wires
stripping



SELV
Class III

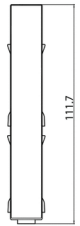

9503-S/B-E
9503-S/W-E
JOINTING CONNECTOR



Snap - in
Fixing



SELV
Class III

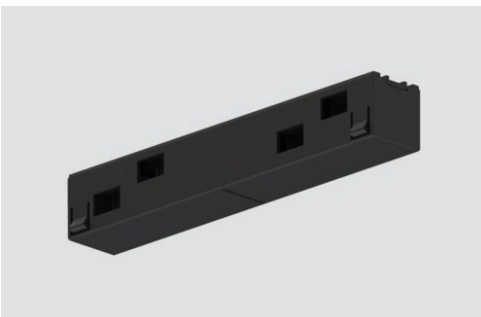
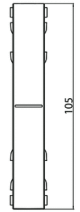

9503-S/B-M-E
9503-S/W-M-E
MECHANICAL JOINTING CONNECTOR



Snap - in
Fixing



SELV
Class III

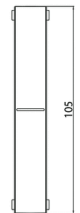

9511/B-E
9511/W-E
L FEED



Snap - in
Fixing



SELV
Class III

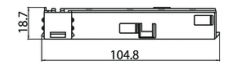
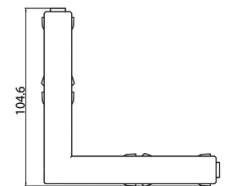

9518-S/B-E
9518-S/W-E
ADJUSTABLE CORNER



Snap - in
Fixing



SELV
Class III

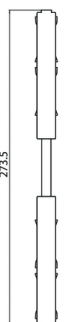

LOW VOLTAGE TRACKS

ST5

Connection joinings accessories



S-9511/316-LA
L BRACKET FOR ANGLES

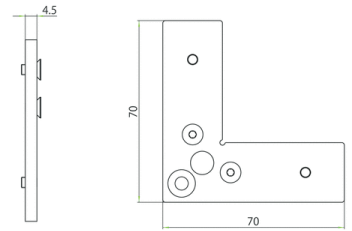

S-9511/B-ST5
EXTERNAL VERTICAL CORNER
JOINT FOR ST5 TRACK

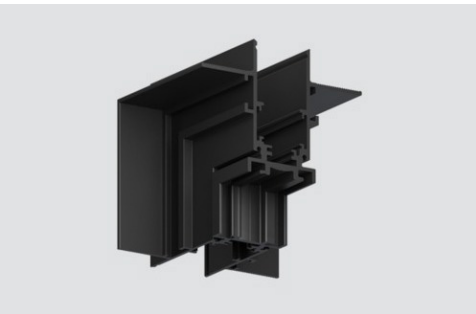
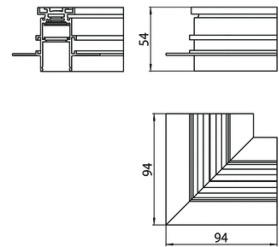

S-9511-E/B-ST5
EXTERNAL VERTICAL CORNER
JOINT FOR ST5 TRACK

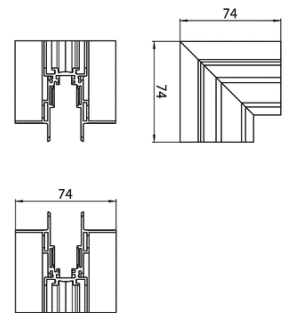

S-9511-I/B-ST5
EXTERNAL VERTICAL CORNER
JOINT FOR ST5 TRACK

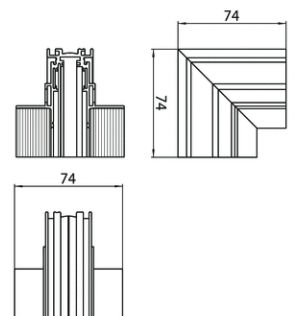

Suspension sets



S-9000-P4
SUSPENSION SET

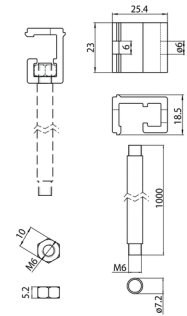

Brackets



S-9500/314-B
S-9500/314-W2
REINFORCING BRACKET
FOR TRIMLESS USE OF JOINTING CONNECTOR

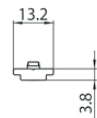
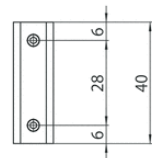

Clamp

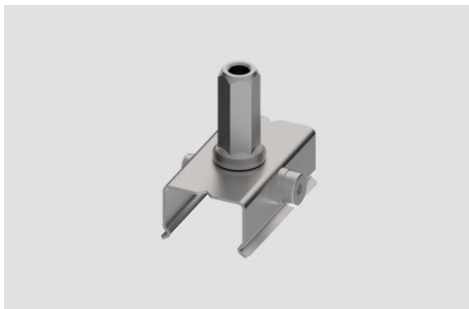

S-9000-P2/117
CLAMP WITH M6 GRIPPER

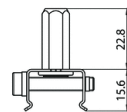
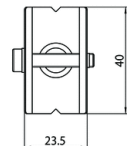

S-9000/118
S-9000/118-B
S-9000/118-W2
FAST FIXING CLAMP WITH
M6 THREADED GRIPPER

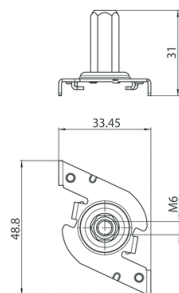

Cups



S-9000/3-B
S-9000/3-W
PLASTIC CUP FOR STEEL CABLE Ø 1,5 MM

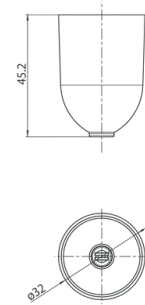

S-9000/216
ROUND HEAD CEILING ATTACHMENT WITH HOLE

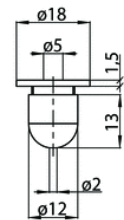

Ceiling fixing Brackets



S-9000/132
CEILING BRACKET FOR SUSPENSIONS

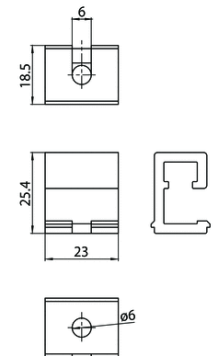

Stem



S-9000-1,2/604-B
S-9000-1,2/604-W2
STEM WITH M13x1 END AND NUT

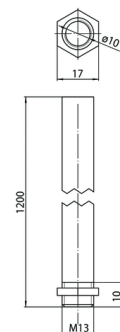

LOW VOLTAGE TRACKS

ST5

Cables



S-9000/211-1,5
S-9000/211-3
S-9000/211-5

STEEL CABLE

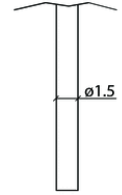

S-9000/211-S-1,5
S-9000/211-S-3
S-9000/211-S-5

STEEL CABLE WITH SPHERICAL END

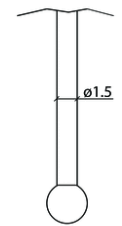

Grippers



S-9000/214
AUTOMATIC LOCK

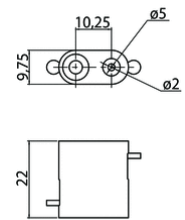

S-9000/215
SCREW GRIPPER

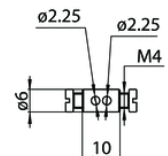

LOW VOLTAGE TRACKS

ST5

Grippers



S-9000/218
AUTOMATIC M5 GRIPPER WITH SIDE HOLE

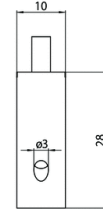

602/F
SET SCREW FOR GRIPPER ON THE BRACKET

