

NOTUS 2 LINEAR LED

☉ indoor/ profiles

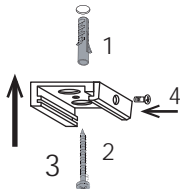

1 Measure distances for suspensions or mounting systems
Adjust the suspension or the mounting system.



A Ceiling mounted

B Ceiling suspension

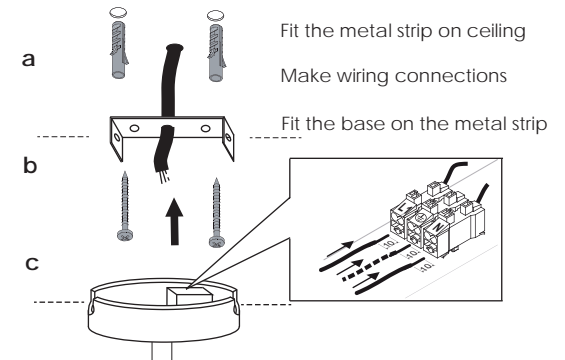
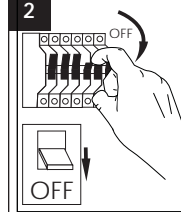
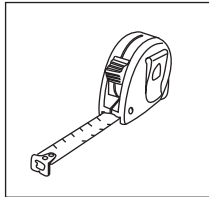
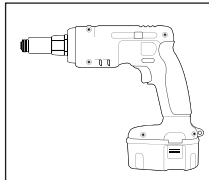

3 Tighten the screws till the base is secure against ceiling

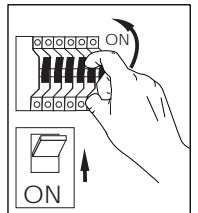
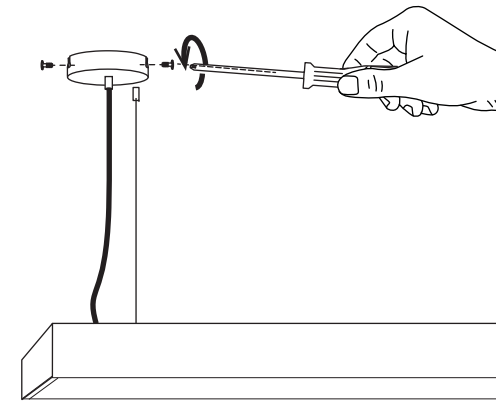

USER INSTRUCTIONS

- The installation of the unit must be done by a qualified electrician.
- The unit must be earthed in case an earth connecting point exists.
- Ensure that the mains is switched off during servicing.
- Do not use bulb(s) bigger than the indicated on units name-plate or packaging.
- Ensure that after the installation, the unit is properly fixed and the cable clamps (if exist) are well tightened.
- Manufacturer will not accept liability for injury or damage resulting from incorrect use or installation
- The unit is not intended to operate in loop connection.
- Wall plugs and terminals are not included.
- LED modules are replaced only by the manufacturer.

CAUTION
Wear anti-static gloves
before you touch LED systems

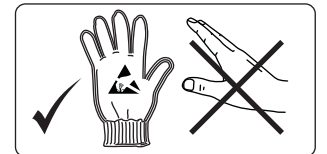

CAUTION
Replace any cracked shield

