

NUDO WALL Q H.P.LED

⊕ outdoor

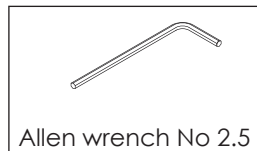

1 Unscrew the base with an allen wrench.

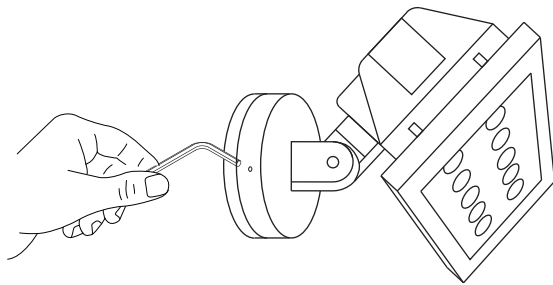

Allen wrench No 2.5

2 Screw base on the wall.
Please notice the silicone gasket.
Do not remove it.

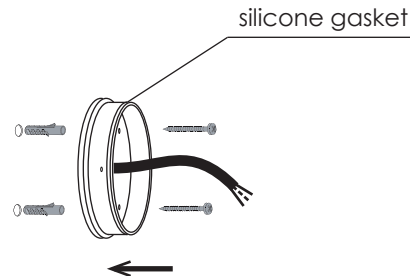
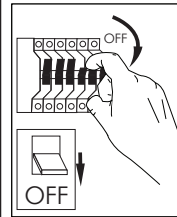

3 Make wiring connections.

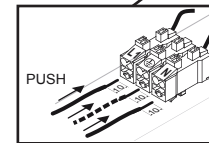
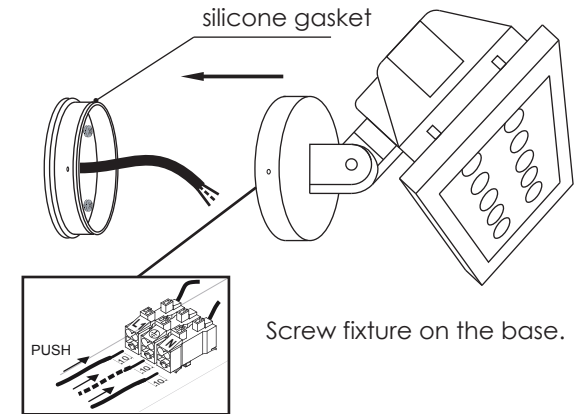

Screw fixture on the base.

4 Rotate to focus.

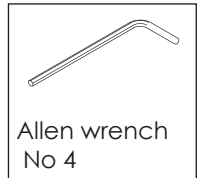
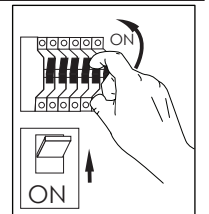
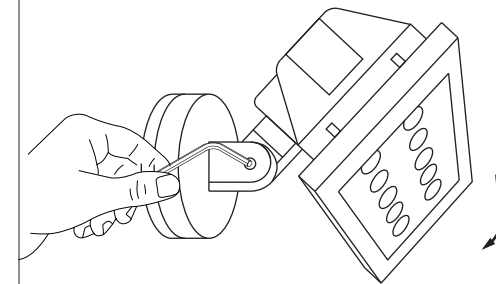

Allen wrench No 4

USER INSTRUCTIONS

- The installation of the unit must be done by a qualified electrician.
- The unit must be earthed in case an earth connecting point exists.
- Ensure that the mains is switched off during servicing.
- Do not use bulb(s) bigger than the indicated on units name-plate or packaging.
- Ensure that after the installation, the unit is properly fixed and the cable clamps (if exist) are well tightened.
- Manufacturer will not accept liability for injury or damage resulting from incorrect use or installation
- The unit is not intended to operate in loop connection.
- Wall plugs and terminals are not included.
- LED modules are replaced only by the manufacturer.

IP65

CAUTION
Wear anti-static gloves before you touch LED systems.



CAUTION
Replace any cracked shield.



Factory
5 Kefalovrisou Str., Monomati, Acharnai, P.O. Box 13677, Athens, Greece | Tel: (+30) 210 6208 230
E-mail: info@bright.gr | www.bright.gr

