

SERIES-L

INSTALLATION INSTRUCTIONS

IMPORTANT SAFEGUARDS

When using electrical equipment, basic safety precautions should always be followed including the following:

READ AND FOLLOW ALL SAFETY INSTRUCTIONS

1. To avoid the possibility of electrical shock, turn off power supply before installation or servicing. Installation and servicing should be performed by qualified personnel.
2. When closing cover of fixture, be sure all wires are inside housing to avoid pinching wires.
3. If Photo Receptacle is installed refer to "Photo Control" section for Product must be installed in accordance with your local electrical code.
4. If you are not familiar with these codes and requirements, consult a qualified electrician
5. Do not change the structure or any components of the fixture to ensure safety.

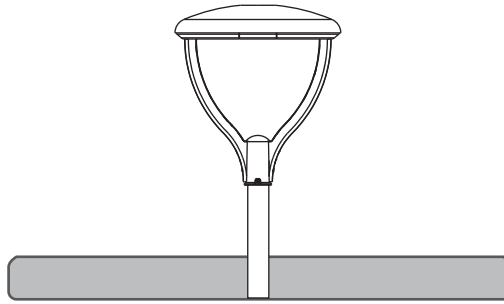

100-240V/277V AC, 50/60Hz, Suitable for Wet Locations (IP66), Class I
 *Only suit for outdoor use. Max installation height: 15M.
 *Normal operating position is on a mast arm or post top or steel wire.
 *This product must be grounding

SAVE THIS INSTRUCTIONS FOR FUTURE REFERENCE

Power	Pendant Mounted		Side Entry Mounted		Suspended Mounted		Post Top Mounted		EPA
	Dimension	Weight	Dimension	Weight	Dimension	Weight	Dimension	Weight	
27W	Φ480*204mm	7.8 kg	Φ480*209mm	8.6 kg	Φ480*240mm	8.4 kg	Φ480*521mm	8.8 kg	0.276m ²
37W	Φ480*204mm	7.8 kg	Φ480*209mm	8.6 kg	Φ480*240mm	8.4 kg	Φ480*521mm	8.8 kg	0.276m ²
56W	Φ480*204mm	7.8 kg	Φ480*209mm	8.6 kg	Φ480*240mm	8.4 kg	Φ480*521mm	8.8 kg	0.276m ²
70W	Φ480*204mm	8.9 kg	Φ480*209mm	8.8 kg	Φ480*240mm	8.6 kg	Φ480*521mm	8.9 kg	0.276m ²
90W	Φ480*204mm	9.2 kg	Φ480*209mm	9.0 kg	Φ480*240mm	8.8 kg	Φ480*521mm	9.2 kg	0.276m ²
120W	Φ480*204mm	9.2 kg	Φ480*209mm	9.1 kg	Φ480*240mm	8.9 kg	Φ480*521mm	9.2 kg	0.276m ²

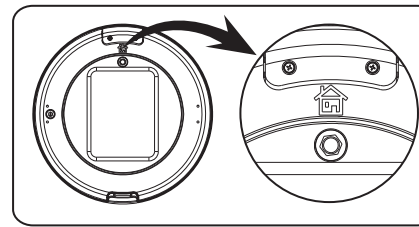
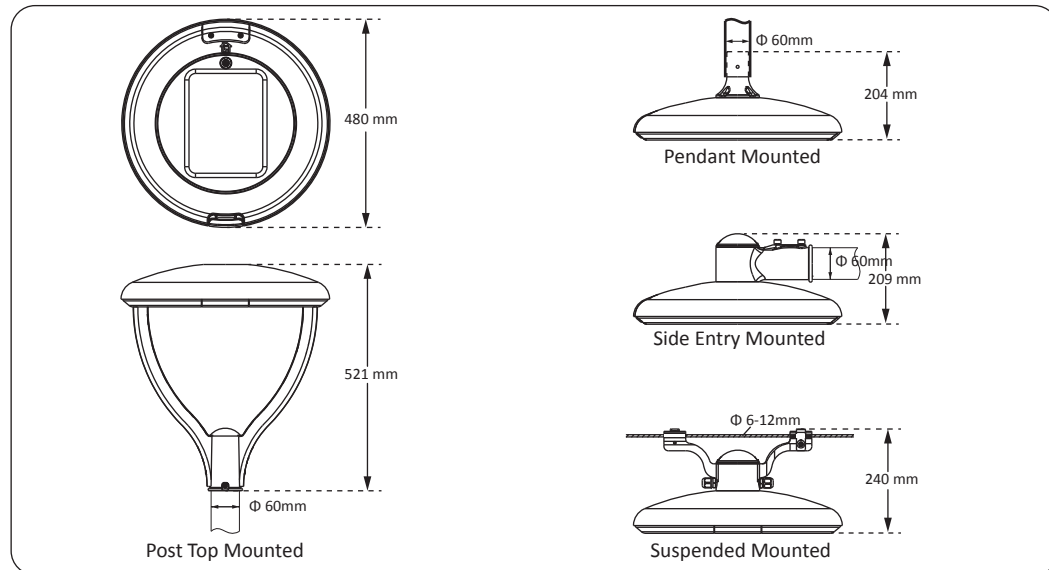

NOTICE

When install the luminaire, please be advised that the sign on the luminous surface should be in the direction of house side.

PENDANT MOUNTED

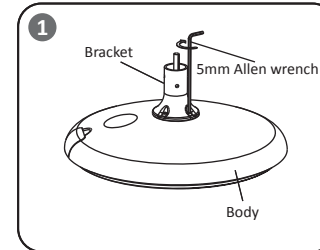

1. Fix the bracket to the luminaire body by 5mm Allen wrench.

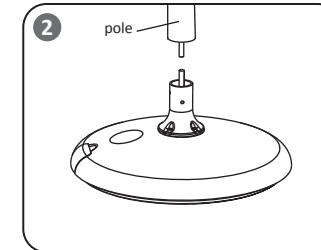

2. Connect the power cord and then insert the pole.

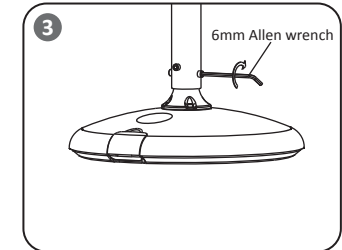

3. Fix the luminaire to the pole by 6mm Allen wrench.

Note: Internal diameter of the pole should be 60mm.

SIDE ENTRY MOUNTED

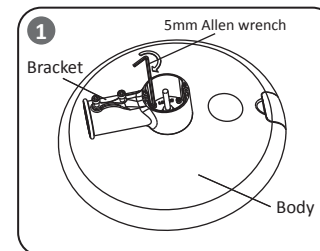

1. Fix the bracket to the luminaire body by 5mm Allen wrench.

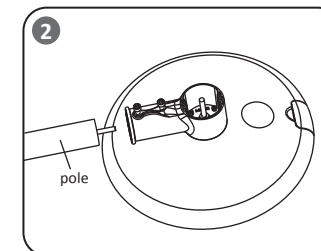

2. Connect the power cord and then insert the pole.

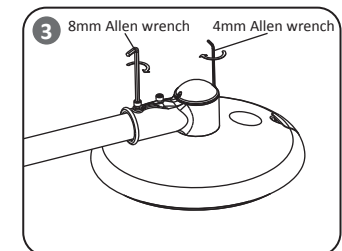

3. Fix the luminaire to the pole by 8mm Allen wrench. Then fix the cover to the luminaire by 4mm Allen wrench.

Note: External diameter of the pole should be 60mm.

SUSPENDED MOUNTED

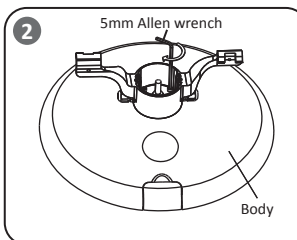
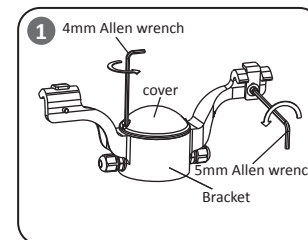

1. Open the cover by 4mm Allen wrench. Then remove the steel wire tabletting by 5mm Allen wrench on the bracket.

2. Fix the bracket to the luminaire body by 5mm Allen wrench. Please pay attention to the luminaire direction.

3. Fix the luminaire to the steel wire. Then connect all the wires.

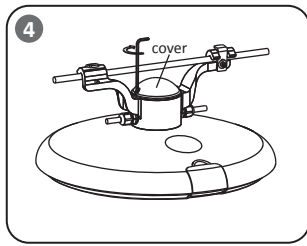
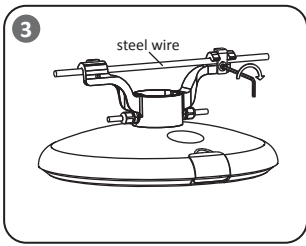

4. Fix the cover to the luminaire by 4mm Allen wrench.

Note: External diameter of the rope should be 6-12mm.

POST TOP MOUNTED

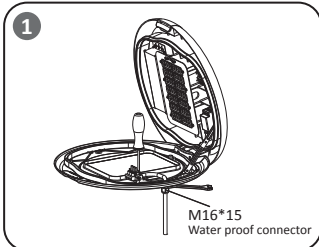

1. Fix the M16*15 water proof connector to the luminaire. Open the luminaire and connect the wire to the power turn off protector. Adjust the length of wire and tighten the M16*15 water proof connector.

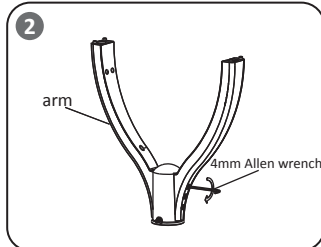

2. Fix the arms to the fitter with M5*12 screws and M5 spring washer by 4mm Allen wrench.

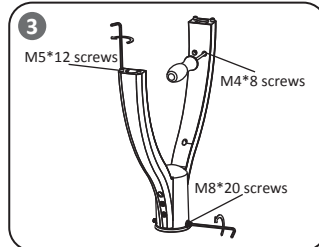

3. Remove M5*12 screws and M5 spring washer on the top of the arms by 4mm Allen wrench. Loosen the M8*20 screws on the fitter. Then remove M4*8 screws and take off the cover of the arm.

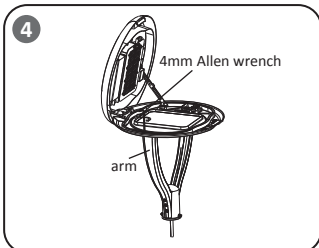

4. Fix the arms to the luminaire body with M5*12 screws and M5 spring washer by 4mm Allen wrench. Then take the wire through the arm.

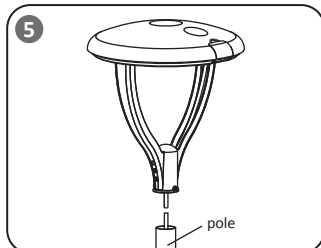

5. Connect the input wire and existing external power cord. Then insert the pole.

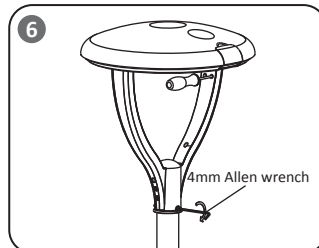

6. Fix the luminaire and pole with M8*20 screws by 4mm Allen wrench and then fix the other cover with M4*8 screws to the arm.

Note: External diameter of the pole should be 60mm.

PHOTO CONTROL (OPTIONAL)

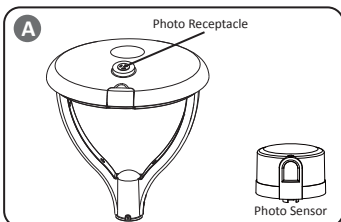

If the fixture with PHOTO CONTROL function, the Photo Receptacle will be installed on the cover of fixture. See **A**. Fit the pins of Photo Sensor to Photo Receptacle, firmly insert and rotate Photo Sensor to proper position.

<Verifying>

Make sure all the connections done and photo control is well installed on the fixture, switch on the power supply and cover the window of photo sensor, wait 5 seconds, the fixture will be turned on.

IMPORTANT

Check whether it concerns an AC(Alternating Current) based or DC(Direct Current) based system.

ELECTRICAL CONNECTIONS - 100-240V/277V AC, 50/60Hz

Class I BASED

STEP 1:

Make the following Electrical Connections:

- Connect **INPUT GROUND** conductor to **middle** position of the surge protector or the female power turn off protector plug.
- Connect **INPUT VOLTAGE** conductor to **"L"** position of the surge protector or the female power turn off protector plug.
- Connect **INPUT NEUTRAL** conductor to **"N"** position of the surge protector or the female power turn off protector plug.

STEP 2:

Make sure all excess input wires are pushed into pole, screws are tightened.

STEP 3:

Close cover by firmly pushing cover towards fixture, making sure that no wires are pinched and Sealing gasket are fully engaged.

STEP 4:

If the fixture without a surge protector, please insulate all electrical connections with wire nuts suitable for at least 90°C

Input cable should be at least H05RN-F 3x1.0mm²(SJTW 18AWG) or outdoor grade cable with rubber sheathed(not supplied). The cable must have a minimum cross sectional area of 1.0mm²(18AWG).

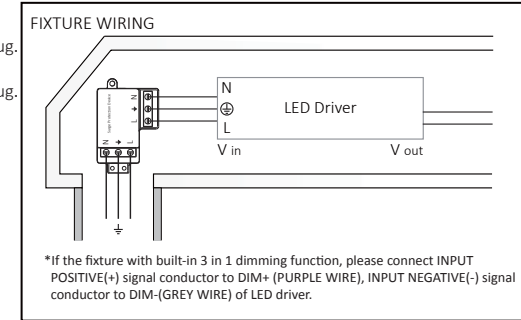

ELECTRICAL CONNECTIONS - 100-240V/277V AC, 50/60Hz

Class II BASED

STEP 1:

Make the following Electrical Connections:

- Connect **INPUT POSITIVE(+)** conductor to **"L"** position of the surge protector or the female power turn off protector plug.
- Connect **INPUT NEGATIVE(-)** conductor to **"N"** position of the surge protector or the female power turn off protector plug.

STEP 2:

Make sure all excess input wires are pushed into pole, screws are tightened.

STEP 3:

Close cover by firmly pushing cover towards fixture, making sure that no wires are pinched and Sealing gasket are fully engaged.

STEP 4:

If the fixture without a surge protector, please insulate all electrical connections with wire nuts suitable for at least 90°C

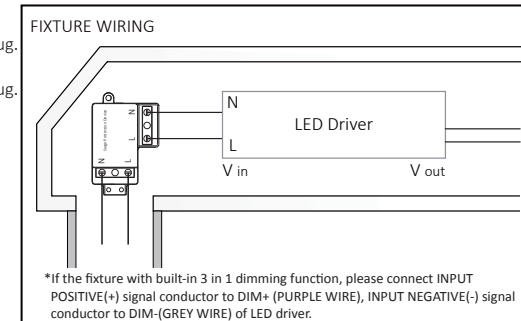

The light source contained in this luminaire shall only be replaced by the manufacturer or his service agent or a similar qualified person.

Caution, risk of electric shock



This marking indicates that this product should not be disposed with other household wastes throughout the EU. To prevent possible harm to the environment or human health from uncontrolled waste disposal, recycle it responsibly to promote the sustainable reuse of material resources. To return your used device, please use the return and collection systems or contact the retailer where the product was purchased. They can take this product for environmental safe recycling.